

TUBOLARI PER SERRAMENTI spessore mm 1,5

2A kg. ml. 1,76

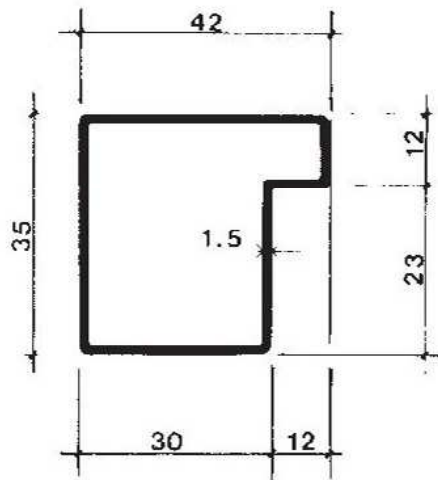

2B kg. ml. 1,88

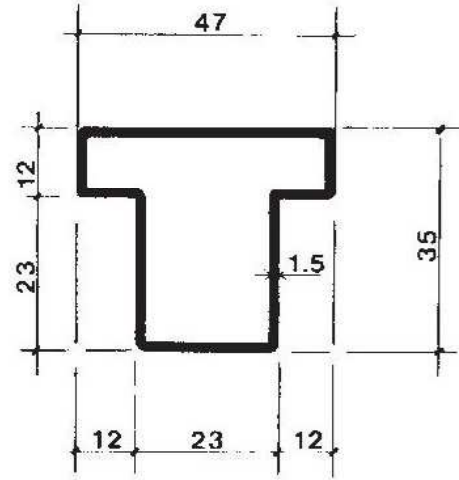

2D SP. 1.5 = kg. ml. 2,78
SP. 2 = kg. ml. 3,66

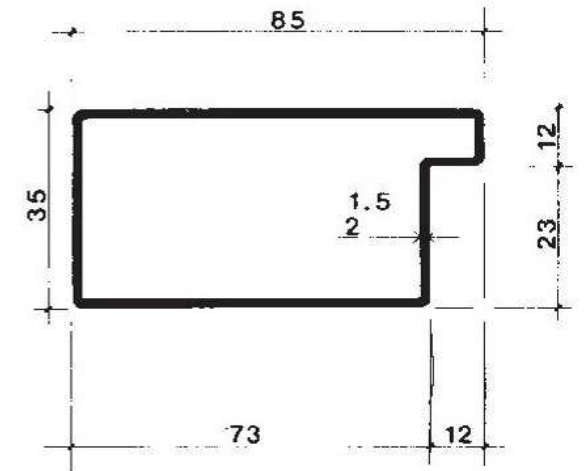

2N kg. ml. 2,30

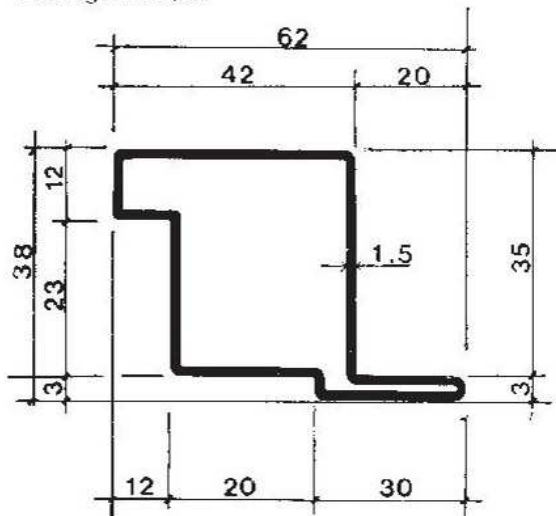

2T kg. ml. 2,30

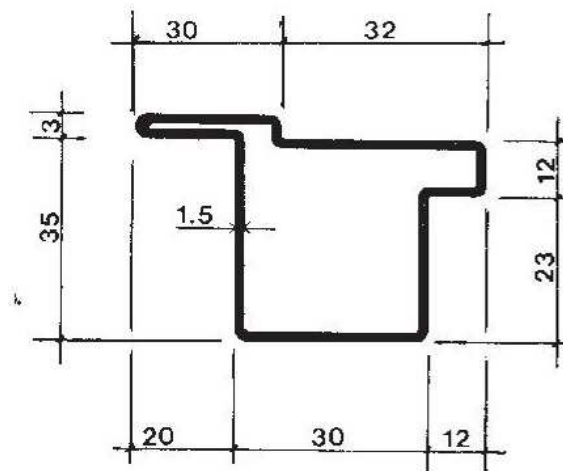

2Z kg. ml. 1,88

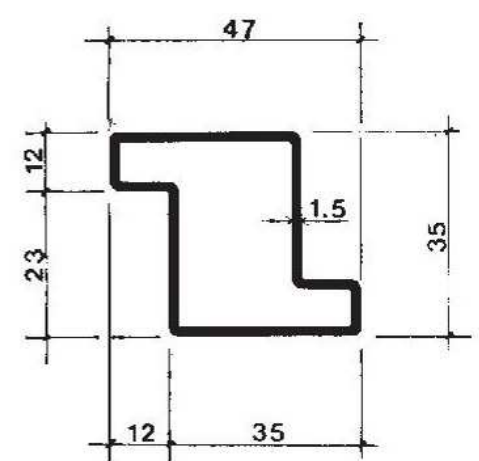

1A kg. ml. 1,72

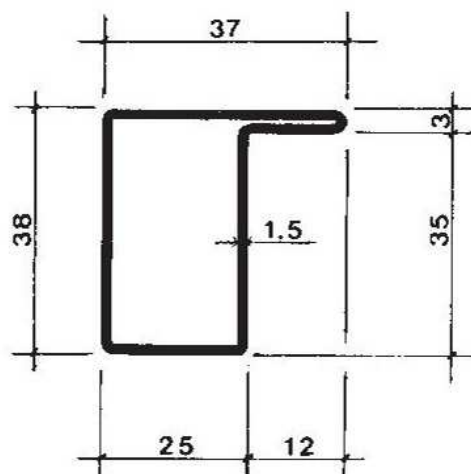

1B kg. ml. 2,10

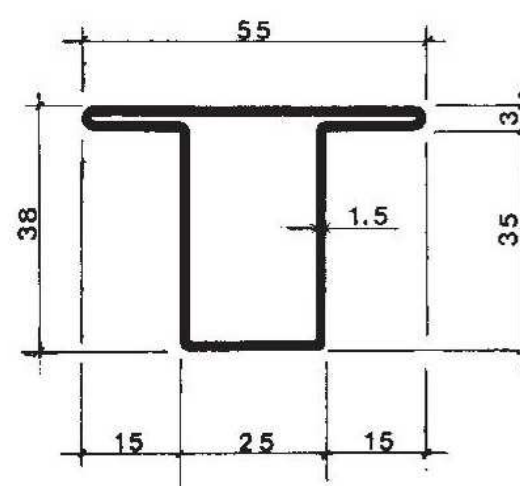

1C kg. ml. 1,99

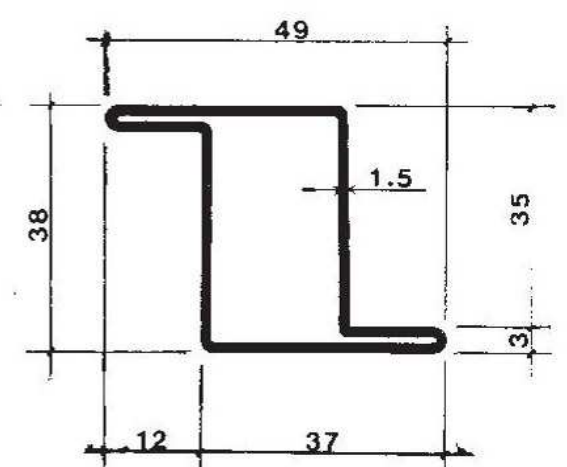

TUBOLARI PER SERRAMENTI spessore mm 1,5

11A kg. ml. 1,34

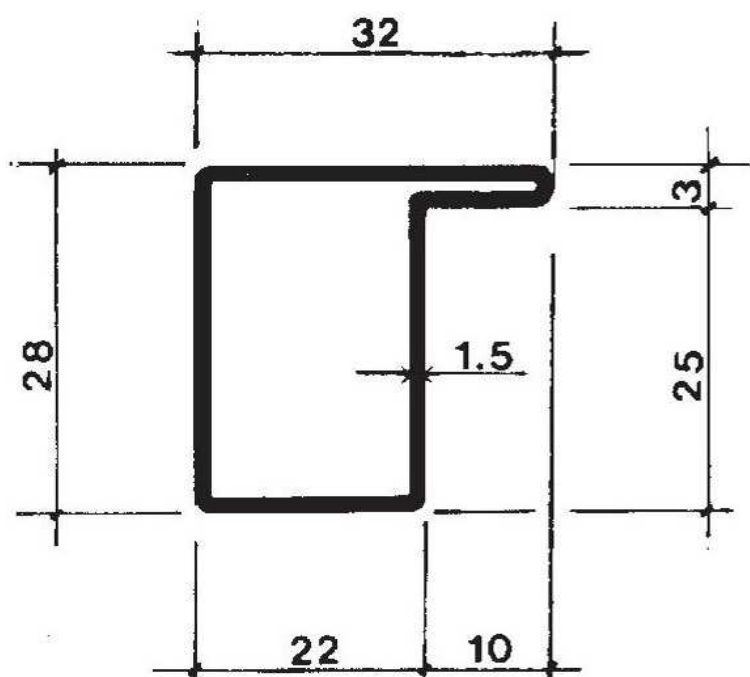

15A kg. ml. 2,04

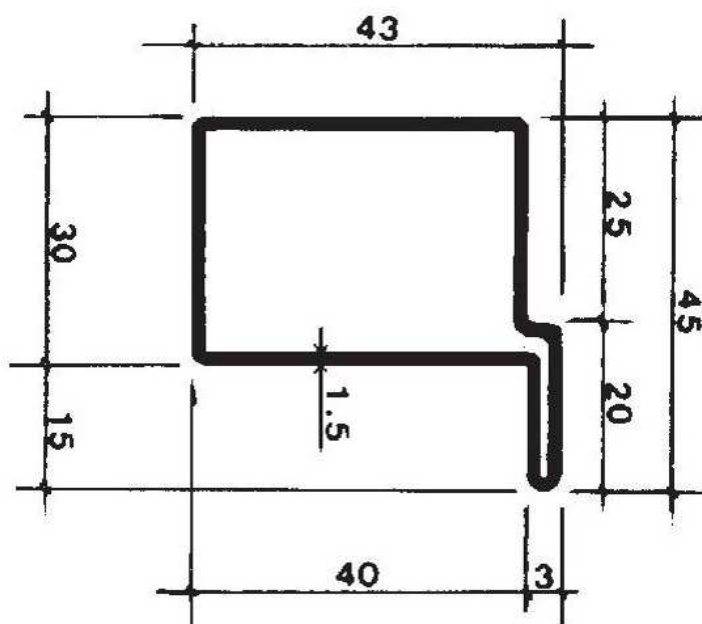

11B kg. ml. 1,57

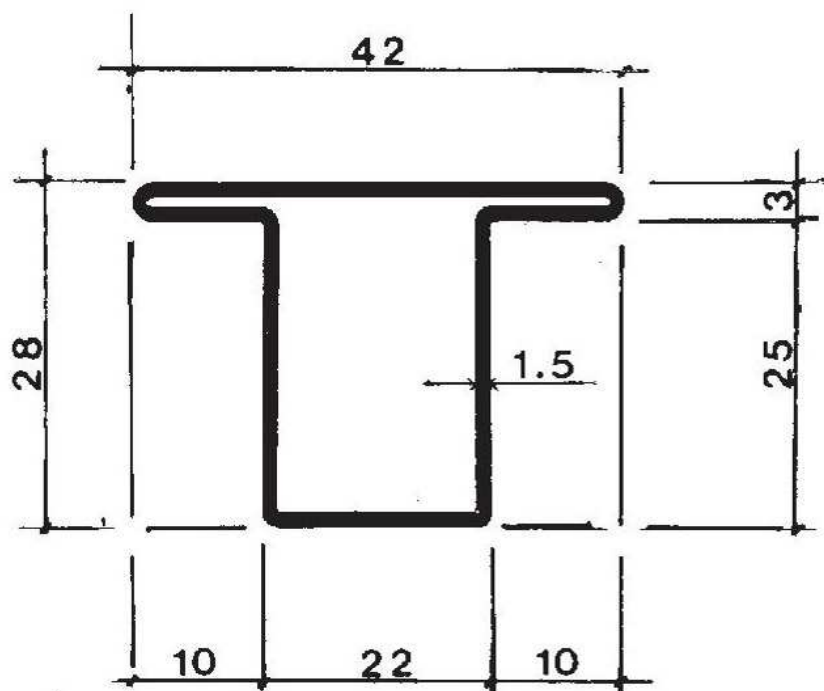

15T kg. ml. 2,45

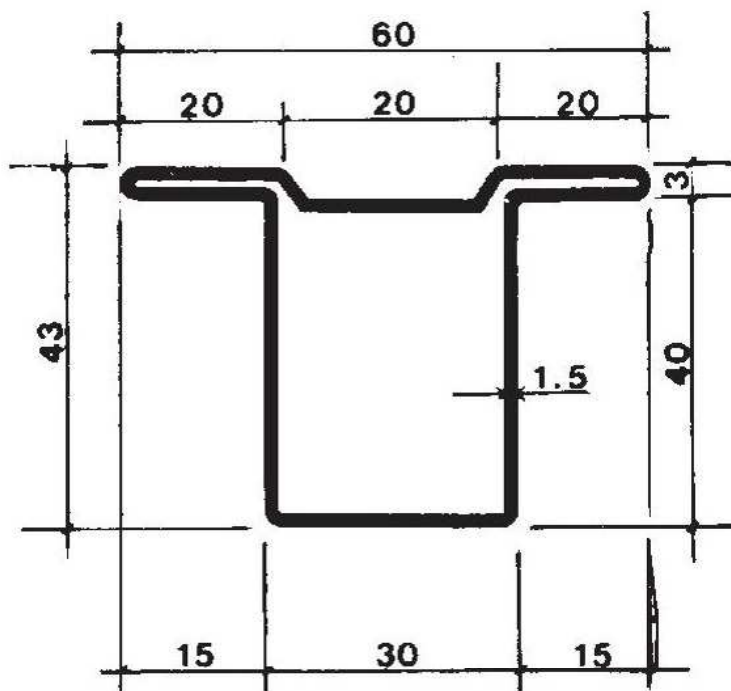

11C kg. ml. 1,57

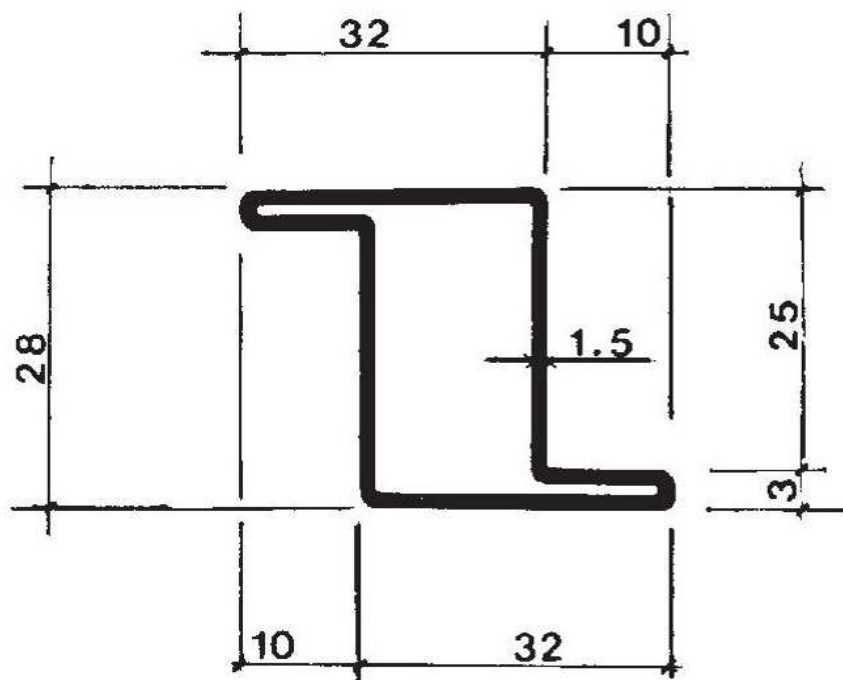

15Z kg. ml. 2,45

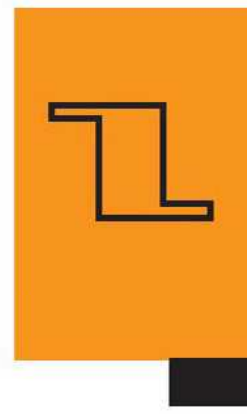
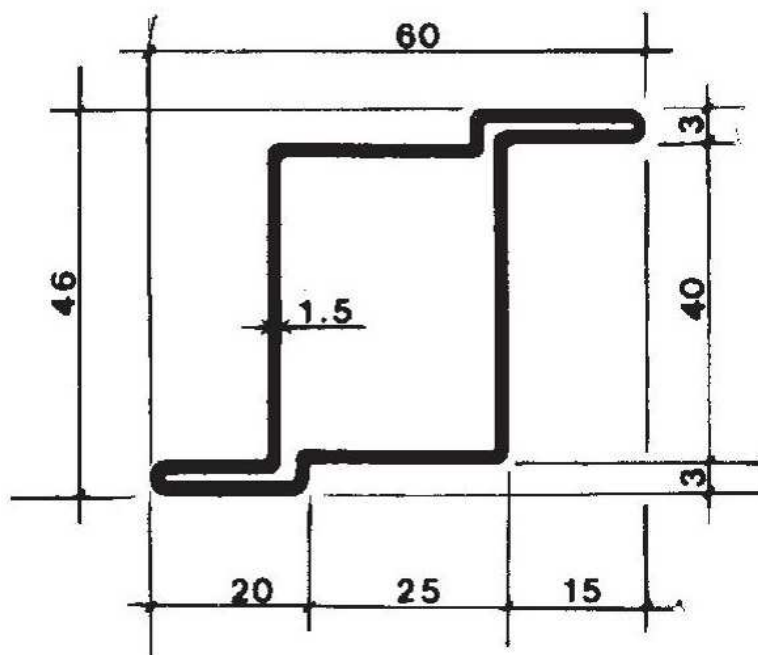

TUBOLARI PER PORTONI spessore mm 1,5

SF1 B kg. ml. 2,15

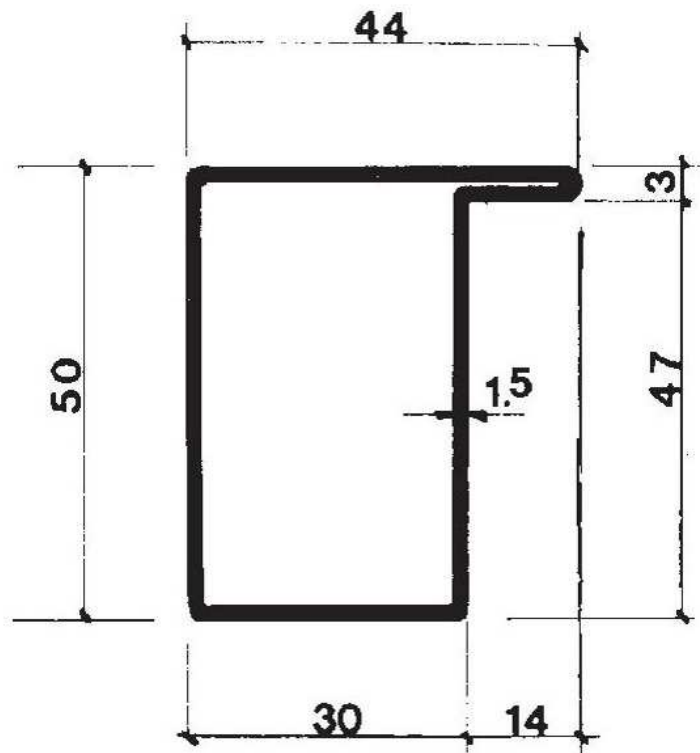

SF2 B kg. ml. 2,52

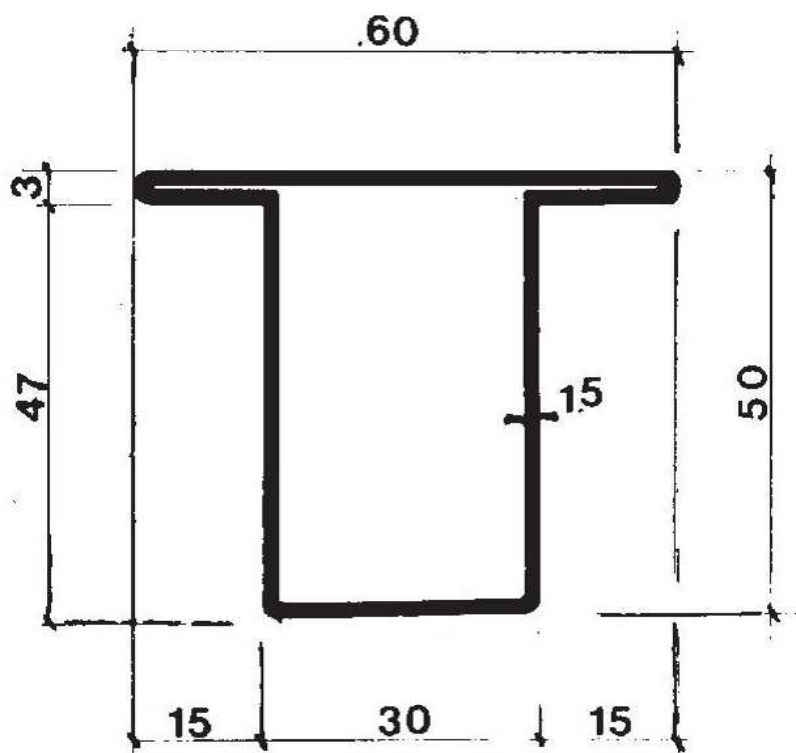

SF3 B kg. ml. 2,52

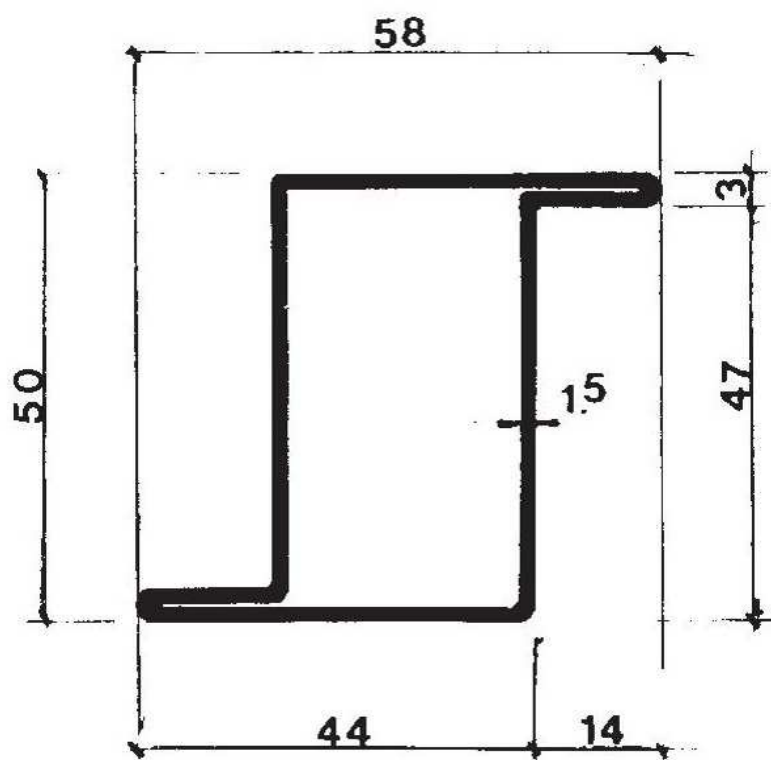

16A SP. 1,5 = kg. ml. 2,33
SP. 2 = kg. ml. 3,08

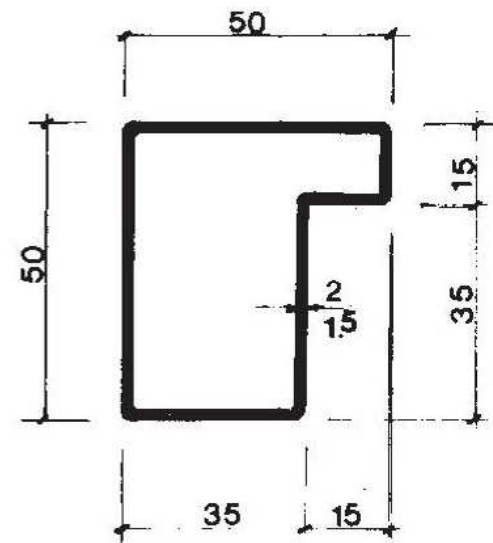

16B SP. 1,5 = kg. ml. 2,33
SP. 2 = kg. ml. 3,08

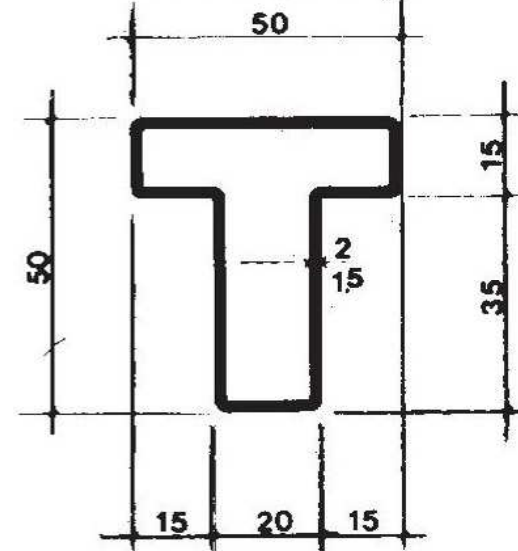

16Z SP. 1,5 = kg. ml. 2,56
SP. 2 = kg. ml. 3,39

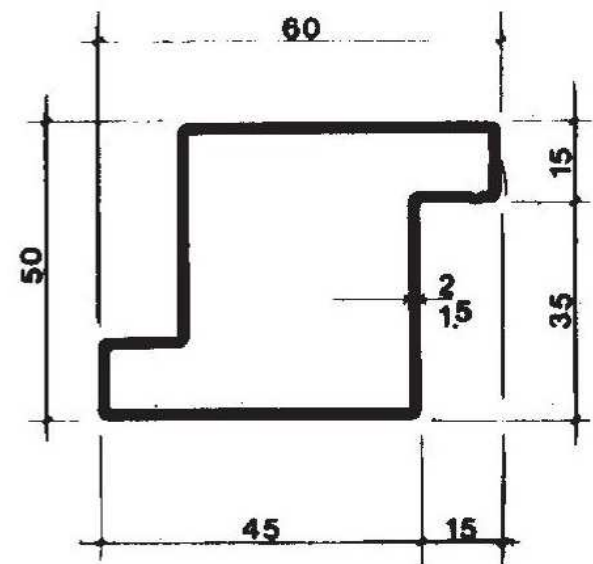

16 D kg. ml. 4,65

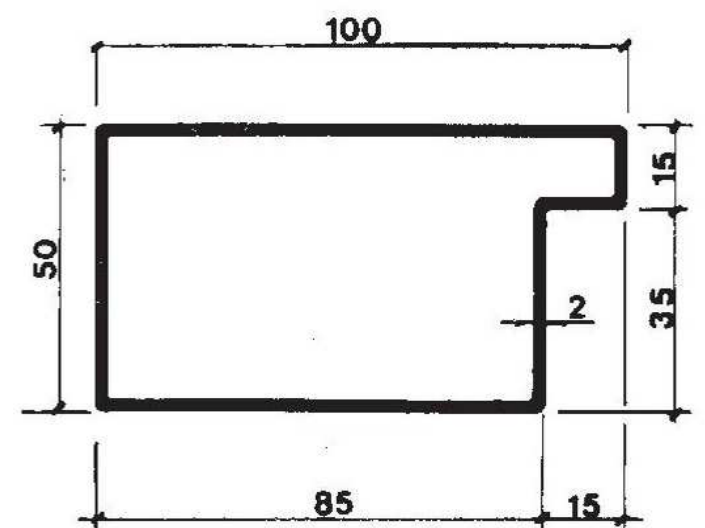

TUBOLARI PER PORTONI spessore mm 1,5

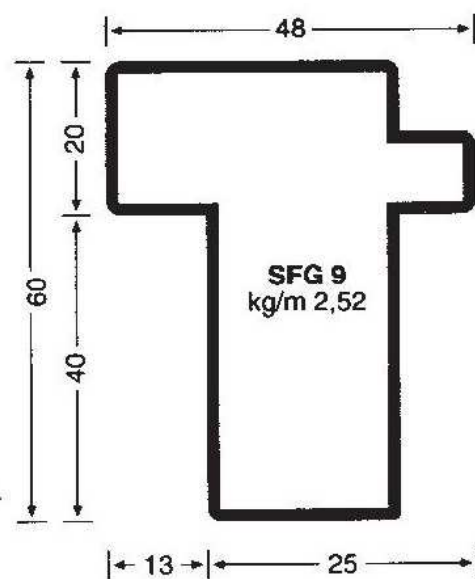
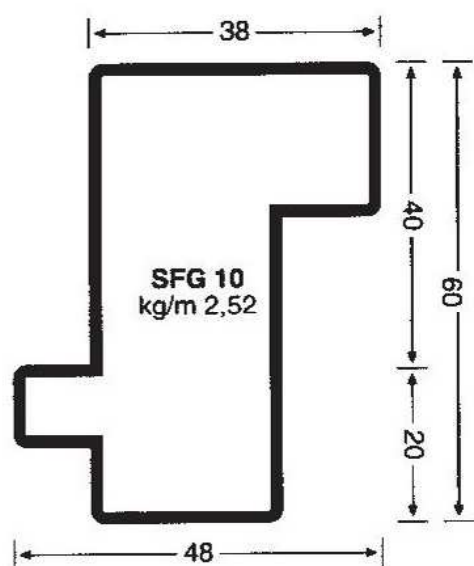

DISPONIBILE
ULTERIORE
GAMMA NON A
CATALOGO
RICAVALI DA
NASTRO
DECAPATO E/O
ZINCATO

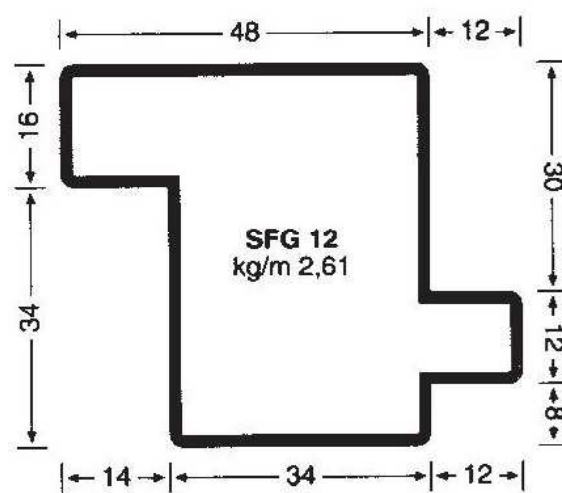
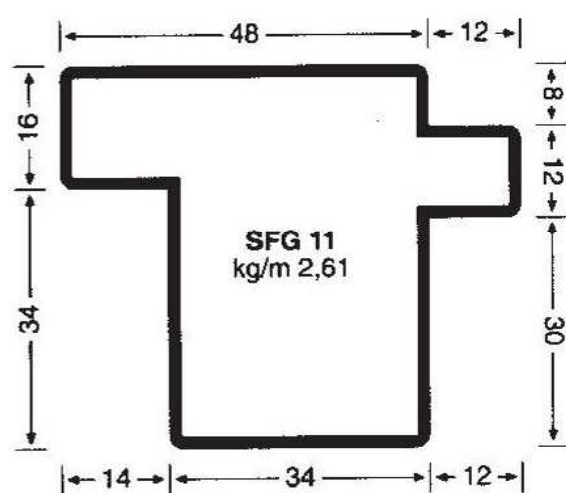

RICAVALI DA NASTRO DECAPATO E/O ZINCATO

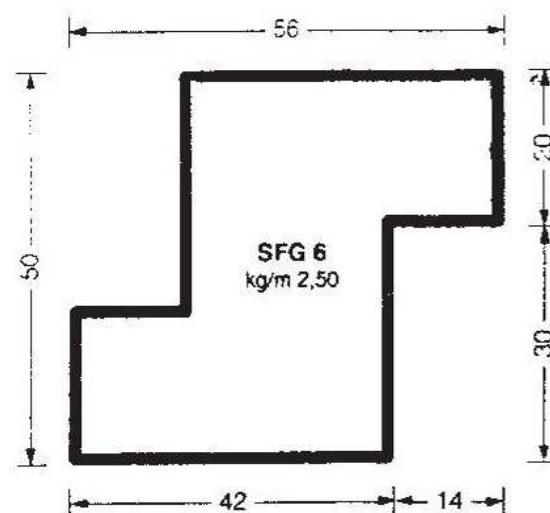
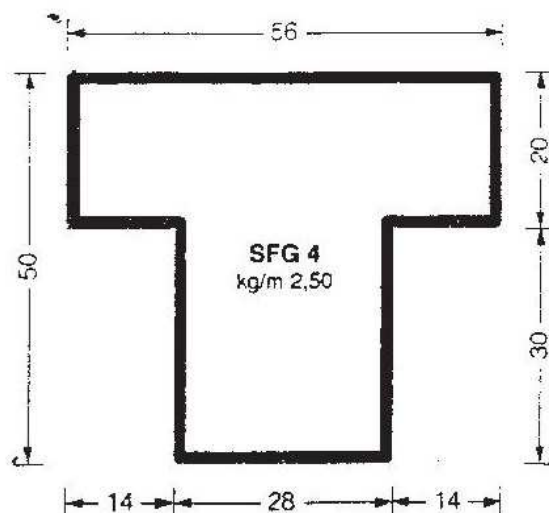
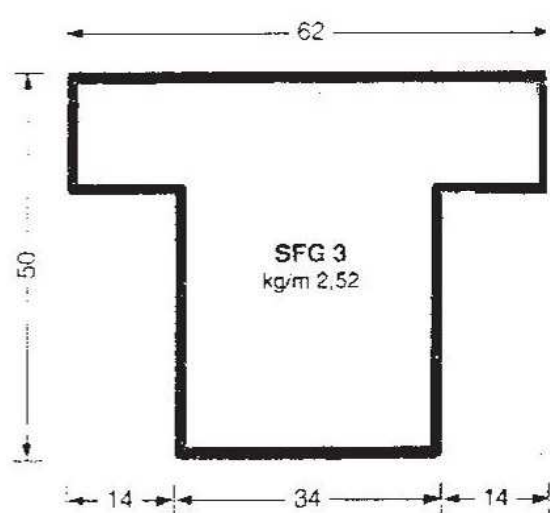
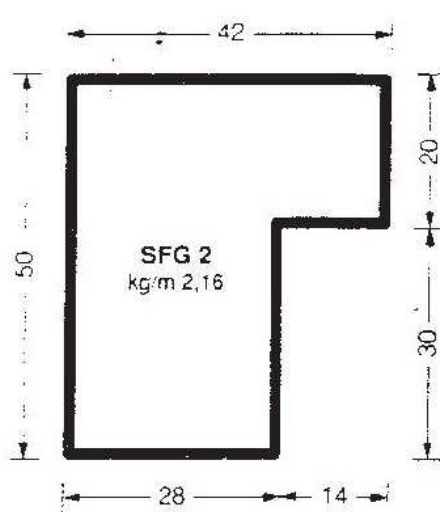
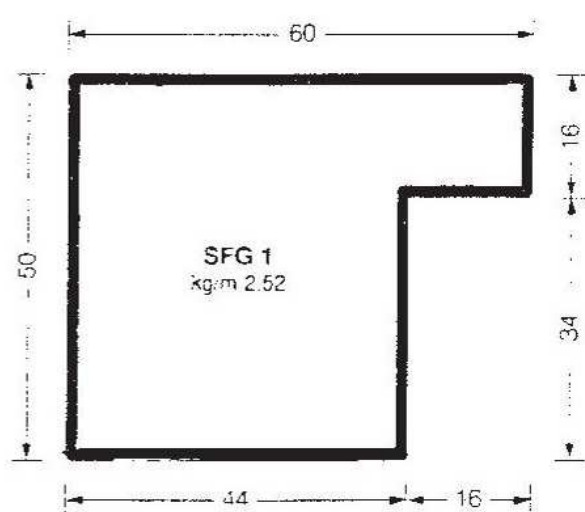

MT 5

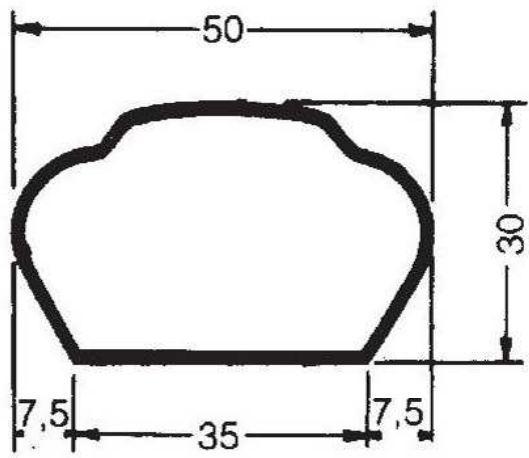

15/10 = kg/ml 1,65

MT 6

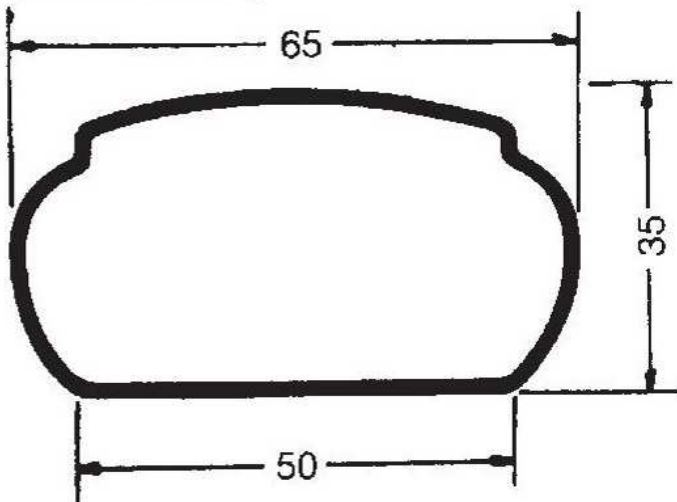

15/10 = kg/ml 2,15

MT 7

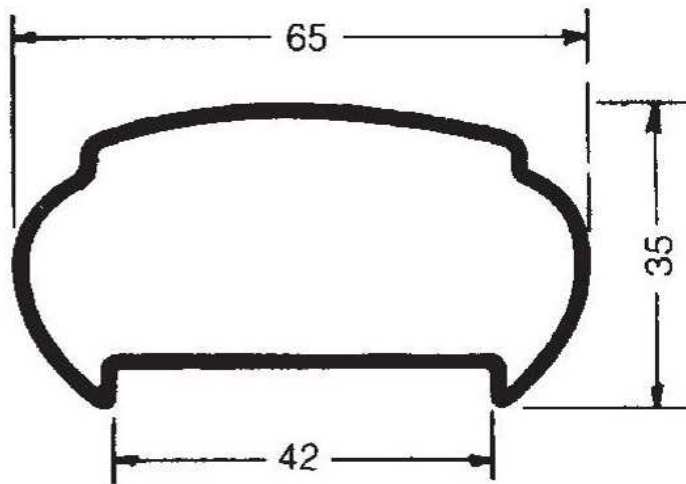

15/10 = kg/ml 2,15

MT 8

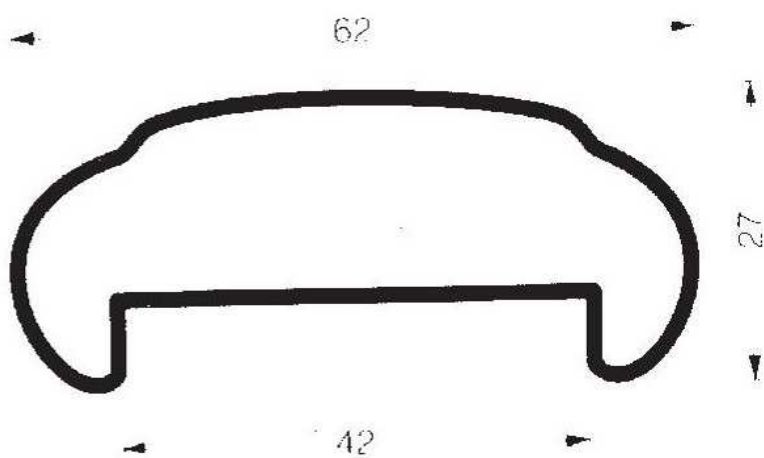

15/10 = kg/ml 1,87

MT 9

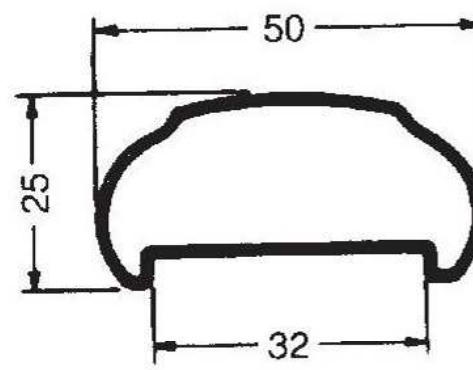

15/10 = kg/ml 1,60

TRIANGOLO
ISOSCELE

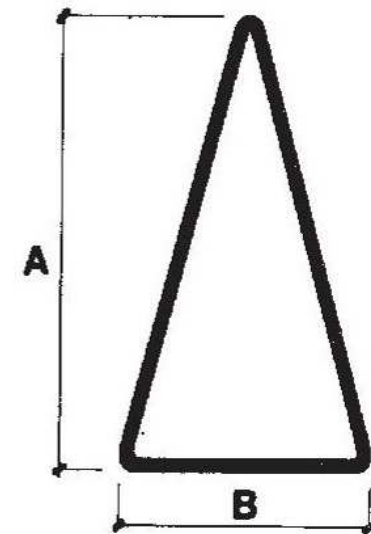

A	30	40
B	15	22
1,5	0,87	1,24
2	1,13	1,63

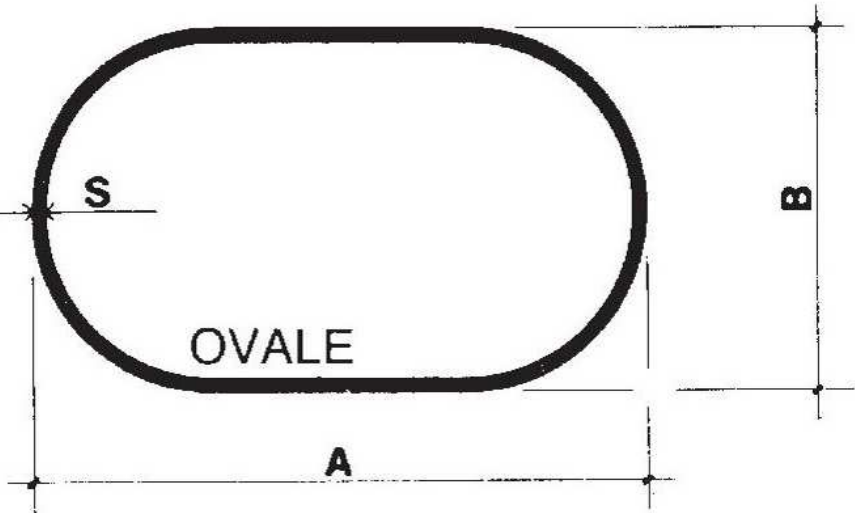

A	30	40	50	50
B	15	20	10	25
1,5	0,87	1,11	1,29	1,54
2	1,13	1,50		1,93